

Failures Analysis and optimization of Reheater Tube

Abdul Kalam Professor, **Prabhupada Senapati** Assistant Professor, **Biswanath Singh** Student
Department of Mechanical Engineering
Einstein Academy of Technology and Management
Bhubaneswar, Khurdha
Odisha, India

Abstract— High pressure boilers are used in modern thermal power station. Any outage in a boiler causes the shutdown of the whole unit. Reheater tube failure is the most frequently listed reason for forced shutdown of boilers. This will lead to forced/ unplanned shut down of power station. In this paper, causes of tube failure and their types are determined. The low grade boiler materials used in reheater does not withstand high temperature, corrosion and erosion during operation. The failure of reheater tubes causes reduction in final temperature,

Keywords— HRH Coil, Reheater, CRH Coil, Tube Failures, Material Selection, Final Temperature, Economy.

I. INTRODUCTION

The problem has been identified in the failures of pressure parts such as SH coils, Water Wall panels, RH coils, Economizer occur over a period of time. The complete detail of failures years and location wise is given in the appendix. Our project focuses on the failure of re-heater tubes, since the failure was becoming more deteriorated re-heater coils so that forced outage during operation is avoided.

Re-heater is a part where steam from high pressure gains some heat before expanding in the intermediate and low temperature turbines.

Re-heater has two headers namely Cold Re-Heater Header (CRH) and Hot Re-heater Header (HRH). The failure occurs more frequently in the HRH side of re-heater tube. Re-heater tubes made of low grade (T22) boiler material which is over heated due to scaling and starvation. Over heating causes failure of boiler tubes. This is reduction in final temperature.

II. REHEATER

Re-heater is used to raise the temperature of steam, which is exhausted from HP turbine after doing a work. The re-heater is composed of two stages: front pendant and rear pendant sections. There are 59 tubes assemblies in the front pendant and 89 tube assemblies in the rear pendant. The tubes are made of SA 213 T22 grade steel having Cr content of 2.60% and Mo 1.13%. The main causes of re-heater coils are between the platen and final super heater. The main causes of re-heater tube failure erosion, stress corrosion weld defects and punctures.

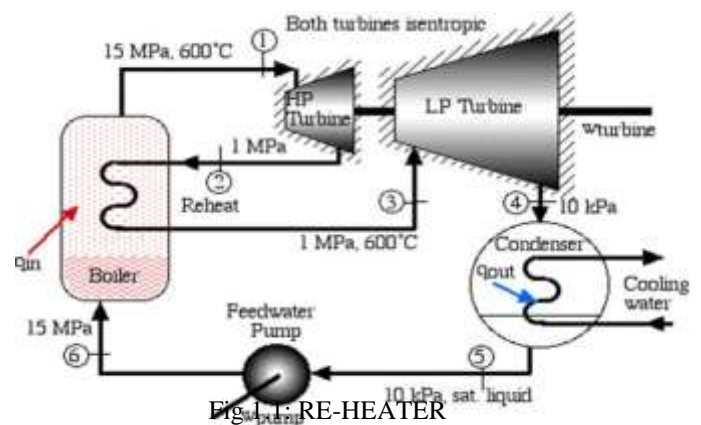

Fig 1.1: RE-HEATER

The steam after doing work in high pressure turbine comes to the front pendant and it passes through the serious of the tube assemblies and goes to the rear pendant. The steam while passing through the tube gets heated by the flue gas so that steam becomes superheated.

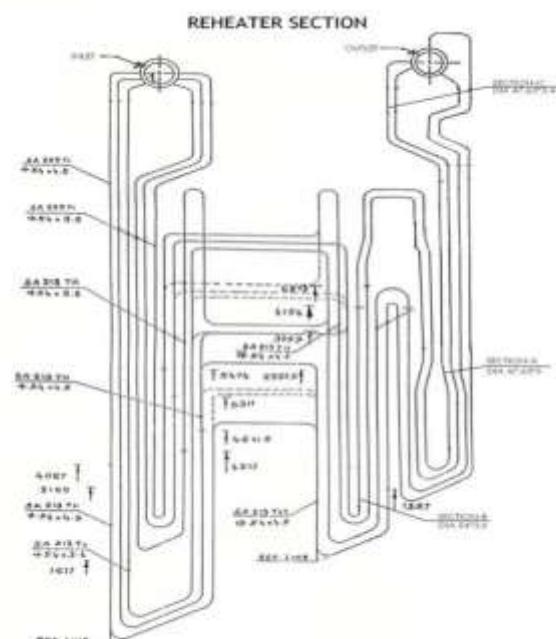

Fig 1.2: RE-HEATER TUBES ARRANGEMENTS

A. Reheating

The efficiency of a rankine cycle can be improved by the increasing in the pressure and the temperature of the steam entering into the turbine. The increases in initial steam pressure will increase the expansion ratio and steam will become quite wet at the end of expansion. The wet steam causes erosion of the turbine blades and increase in the internal losses. This will ultimately reduce the blades efficiency of the turbine. The above mention difficulty may be overcomes by reheating of the steam. In this system the steam is removed from the turbine then it becomes wet.

It is then reheated at constant pressure by the flue gases, until it is again in the super-heated stage. It is then returned to the next stage in the turbine.

III. CAUSES OF FAILURES

Boiler tube failures are inevitable. There are twenty-two primary reasons for tube failures in a boiler. Knowledge and good operating and maintenance practice reduce tube failures. Reducing tube failure in boilers increases the availability of boiler.

Whatever the type of fuel being fired all high pressure boilers are bound to have a tube failure during the course of their working life.

There are six major groups into which all tube failures can be classified. These six groups can be further divided in to a total of twenty-two primary types. All high pressure boilers commissioned and put into operation go through a stabilization period, during which some teething problems occur, including a few tube failures.

A. Classification of tube failures

Tube failures are classified as in-service failures in boilers. These failures can be grouped under six major causes

- a. Stress rupture
- b. Fatigue
- c. Waterside corrosion
- d. Erosion
- e. Fireside Corrosion
- f. Lack of quality control

a. Stress rupture

Pendant-style reheater, constructed of ASME SA-213, grade T-11, steel ruptured. A set of four tubes, specified to be 64 mm outside diameter x 3.4 mm minimum wall thickness was examined. A small quantity of loose debris was removed from the inside of one of the tubes. The major constituent was revealed by Energy-dispersive X-ray spectrometry (EDS) analysis of the debris to be iron with traces of phosphorus, manganese, sodium, calcium, copper, zinc, potassium, silicon, chromium, and molybdenum. Thus the debris was interpreted to be the scale from inside diameter of the tube with boiler feed water chemicals from the attemperation spray. The likely cause of failure was concluded to be

exfoliation of the scale from the inside-diameter surface of the tube. Creep failures were interpreted to be caused by localized temperatures higher than the maximum service temperature. Replacement of the affected tubes was recommended. Inspection of the tubes by radiography to find the circuits with the greatest accumulation of debris and replacing them as necessary was recommended on an annual basis.

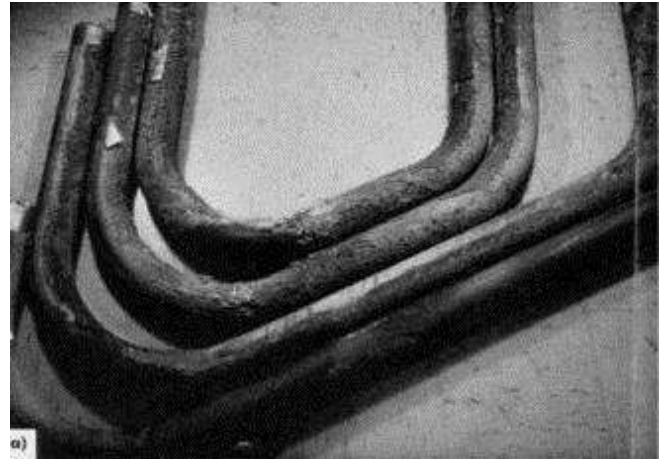

Fig 3.1: Stress rupture

b. Fatigue

Tubes develop a series of cracks that initiate on the outside diameter (OD) surface and propagate into the tube wall. Since the damage develops over longer periods, tube surfaces tend to develop appear and described as “elephant hide”, “alligator hide” or craze cracking. Most commonly seen as a series of circumferential cracks. Usually found on furnace wall tubes of coal-fired once-through boiler designs, but also has occurred on tubes in drum-type boilers.

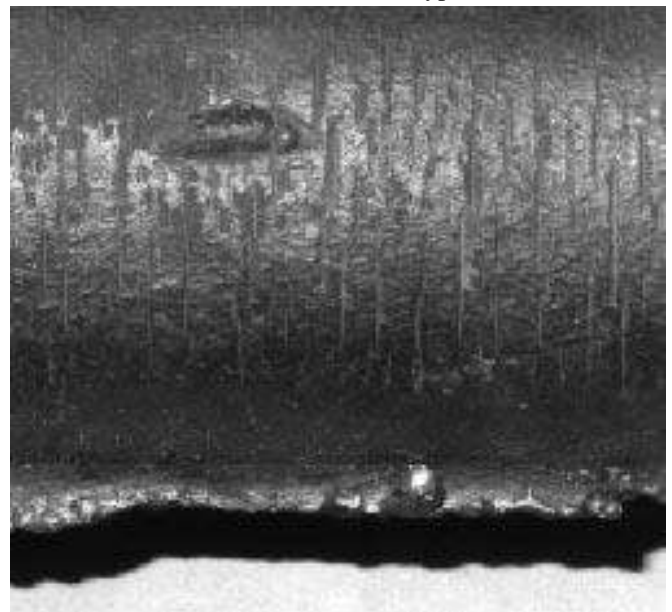

Fig 3.2: Fatigue

c. *Waterside Corrosion*

Tube damage occurs due to the combination of thermal fatigue and corrosion. Corrosion fatigue is influenced by boiler design, water chemistry, boiler water oxygen content and boiler operation. A combination of the effects leads to the breakdown of the protective magnetite on the ID surface of the boiler tube. The loss of this protective scale exposes tube to corrosion. The locations of attachments and external elements, such as backstay attachments, seal plates and scallop bars, are most susceptible. The problem is most likely to progress during boiler start-up cycles.



Fig 3.3: Waterside Corrosion

d. *Erosion*

Erosion of tube surfaces occurs from impingement on the external surfaces. The erosion medium can be any abrasive in the combustion gas flow stream, but most commonly is associated with impingement of fly ash or soot blowing steam. In cases where soot blower steam is the primary cause, the erosion may be accompanied by thermal fatigue.

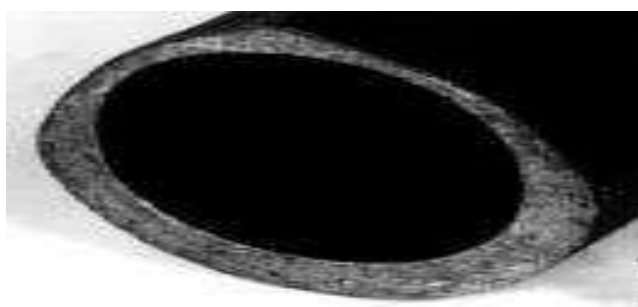

Fig 3.4: Erosion

e. *Fireside Corrosion*

Damage initiation and propagation result from corrosion in combination with thermal fatigue. Tube OD surfaces experience thermal fatigue stress cycles which can occur from normal shedding of slag, soot blowing or from cyclic operation of the boiler. Thermal cycling, in addition to subjecting the material to cyclic stress, can initiate cracking of the less elastic external tube scales and expose the tube base material.

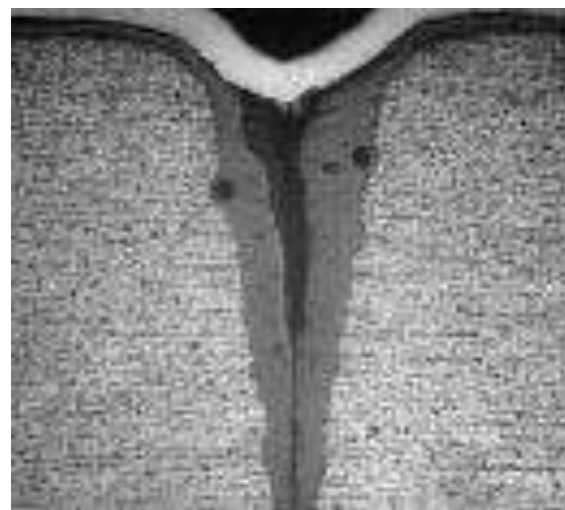

Fig 3.5: Fireside Corrosion

IV. METHODOLOGY

From the various reports and research, it's better to use high grade material at high temperature in re-heater of 210 MW boiler in re-heater instead of using low grade material T22. We prefer to use high grade material to comparing T22 performance with T91 material performance and analyzing using Ansys, Gambit, Fluent, Nastran solver softwares.

A. *Tubes Failures*

The steam outlet from re-heater should be 540°C while using T22 and T91 materials. In re-heater some fluctuation for every 1°C variation from the designed and specific temperature, government is losing 3cores per annum including maintenance and repairing cost.

B. *Materials for Re-heating Tubes*

Generally boiler tube materials need to withstand high temperature and should not corrode easily. The boiler materials should have high creep strength and corrosion resistance, the table shows various materials for reheating tube which withstand high temperature and have good corrosion properties.

Table 4.1: Material Details

S.NO	MATERIALS	Maximum with standing Temperature(°C)
1	T11	600
2	T22	645
3	T91	675
4	ALLOY 617	770

SA 213 T22 ALLOY is the material that is currently being used for reheater tube in thermal power plants.

Major reasons for using stainless steel are

- Resistance to corrosion
- Preservation of product contamination
- Resistance to oxidation
- Ease of Fabrication
- Excellent Formability
- Good Strength and toughness at cryogenic temperature

C. Velocity of Steam

Table 4.2: Variations in Temperature With Velocity

S.NO	VELOCITY OF STEAM (m/s)	STEAM TEMPERATURE	
		INLET(° C)	OUTLET(° C)
1.	61	450	538
2.	55	450	543
3.	50	450	553

Take Assumption For Velocity 50 To 55 m/s

D. Problem Identification

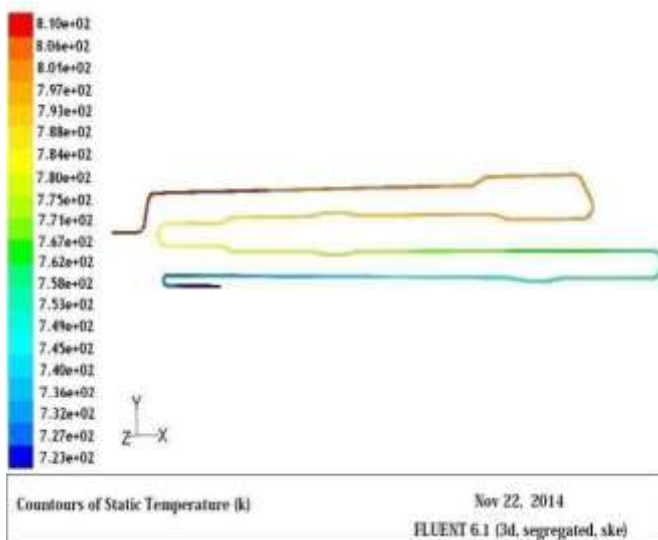

Fig 4.1: Plots Showing the Temperature Variation for 61m/s Steam Velocity

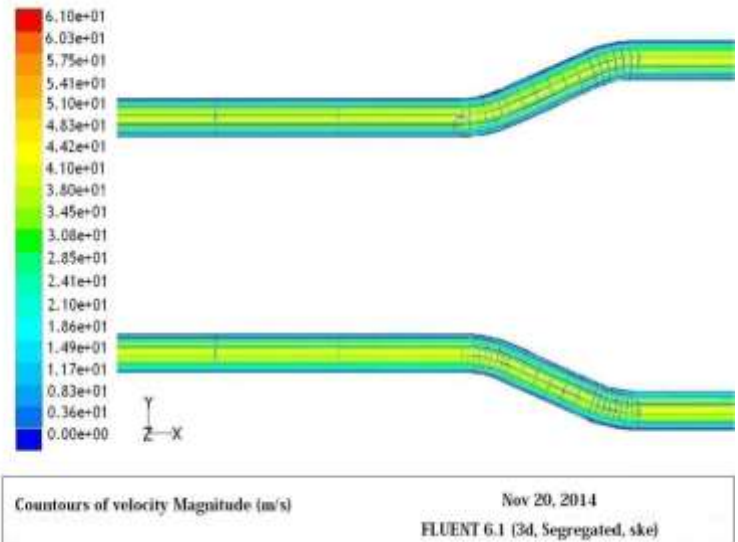

Fig 4.2: Plot Showing the Flow Variation for 61m/s Steam Velocity

V. CONCLUSION

The project discuss on two major remedies which will reduce the reheater tube failure. From the tube failure data we come to conclude that the two major reason for the long term overheating and steam erosion. The usage of high grade material for reheater tube provides extended tube life its better creep strength and this reduce the failure rate due to long term over heating in reheater tube . The loss of power challenges with expected tightening electricity market likely to increase the cost of the boiler tube failure coming at a time when number of failure is expected to rise.

REFERENCES

- [1] Bailey R.W, Ismail, M.Abdulgafur (2009) “Boiler tube failure in natural circulation high pressure drum boiler of a power station” Published in journal of scientific & Industrial research, Vol 68, pp 61-67.
- [2] Cocks C.F. and Leckie F.A (2009) “Weld heat area induced failure of BWWTs in power generation plant” Published in paper ASAT-13-MS-21.
- [3] Korbric G “Study of material selection” ASM hand book, Vol.13, ASM International , metal Park, OH,(1987)
- [4] K.Bhanu Sankara Rao And Baldev Raj (2005) “Case study of support tube failure”, university of Bangalore.
- [5] R.W. Boria “Coal ash deposition in boiler combustion” Engineering Inc.windos USA (1986)
- [6] RD. Herro J.M “Study of the NALCO guide to boiler failure analysis”. New York, McGraw. Hill Inc,(1991)
- [7] William J. Linhart (2008) “Analysis of fire tube failure influenced by dissolved solid in feed water”, Published in journal of scientific & Industrial research.
- [8] Xiaoling Luo, Zhi Zhang (2011) “Study Of Failure Of The Steam Tubes Of Boiler Furnace” Published in Bashrah journal of engineering science.